

# ADVANCED SYSTEM ENGINEERING

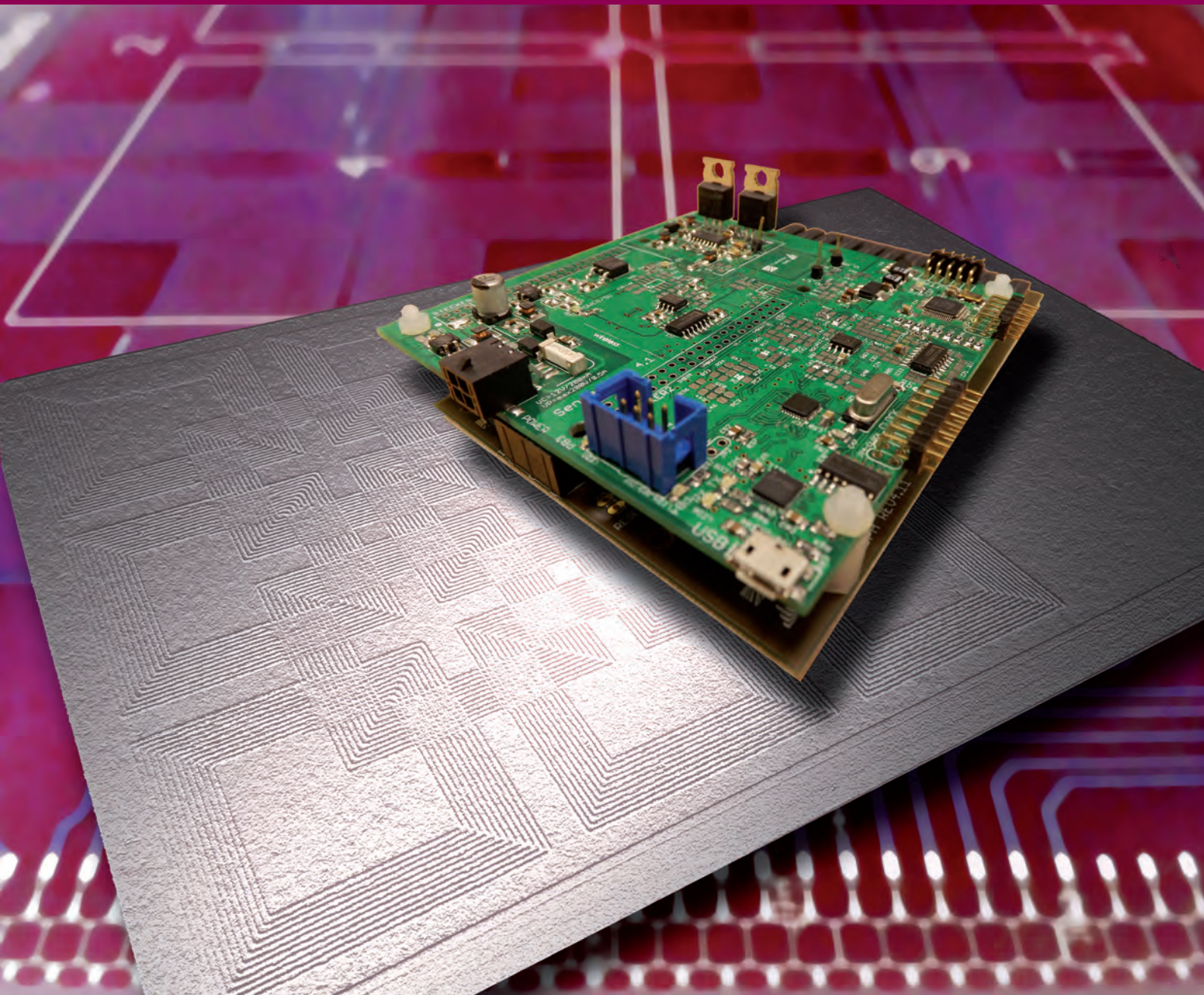

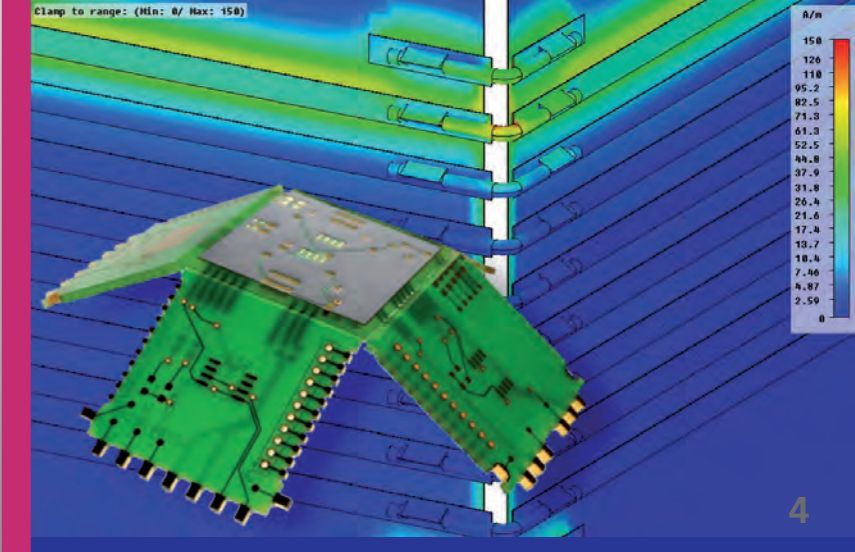
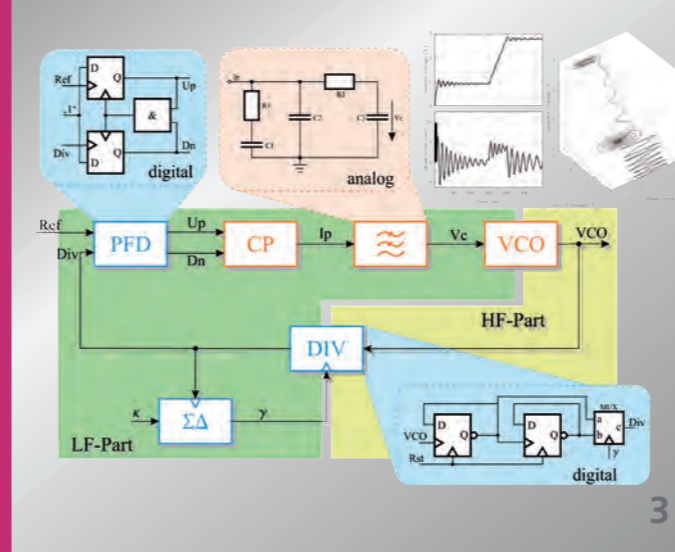
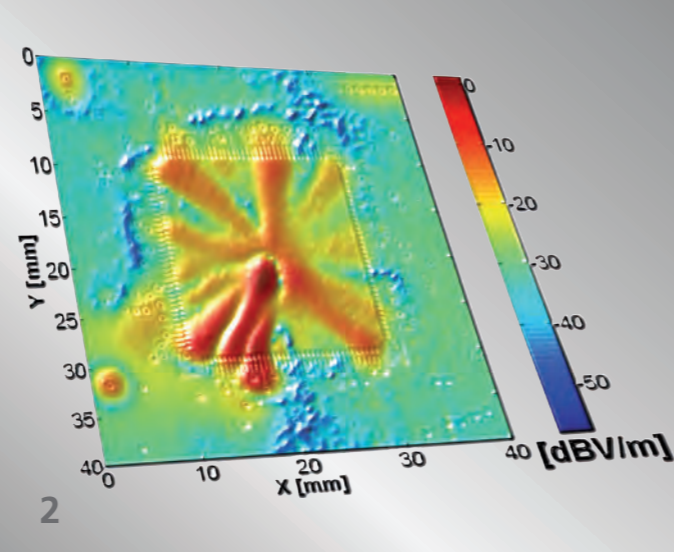

The current developments of micro and nano technologies are fascinating. Undoubtedly they are playing a key role in today's product development and technical progress. With a large variety of different devices, different technologies and materials they enable the integration of mechanical, electrical, optical, chemical, biological and other functions into one system on minimum space.

The Fraunhofer Institute for Electronic Nano Systems ENAS focuses on research and development in the fields of Smart Systems Integration by using micro and nano technologies with partners in Germany, Europe and worldwide. Based on prospective industrial needs, Fraunhofer ENAS provides services in:

- ▶ Development, design and test of MEMS and NEMS (micro and nano electromechanical systems)
- ▶ Wafer-level packaging of MEMS and NEMS
- ▶ Metallization and interconnect systems for micro and nano electronics as well as 3D integration
- ▶ New sensor and system concepts with innovative material systems
- ▶ Integration of printed functionalities into systems
- ▶ Reliability and security of micro and nano systems

The main research effort of the department Advanced System Engineering (ASE) is focusing on designing robust micro and nanoelectronic systems by using efficient simulation methods and by measuring and characterizing precisely their performances. Especially, an expertise in the area of wireless sensor systems including Radio-Frequency and RFID technologies for harsh environments was developed and finds its application in specific

industrial custom needs. Already in the early design stages, the constitution of these systems on both electronic and antenna sides takes all relevant disturbances like conducted or radiated parasitical electromagnetic effects into account. This approach allows to guarantee the electromagnetic compatibility (EMC), the signal integrity (SI) and the electromagnetic reliability (EMR) from the IC-level through packages up to the printed circuit board.

Beside wireless sensing and communicating systems, the department ASE has developed a strong know-how in the area of cordless energy transfer with high efficiency. For this, an optimized antenna array structure combined to a self-adaptive driving power electronics device was designed. This smart combination of antenna and electronics increases both the efficiency and the positioning freedom of the system by limiting drastically the produced electric smog, making the system applicable in close proximity to human beings.

In order to conduct such research, methods for the calculation of electromagnetic fields and circuits are applied at both analog and mixed-signal levels in order to analyze the transmission behavior (i.e. crosstalk, reflection, changes of the nominal signal waveform) in the time and frequency domain. Advanced and precise simulation models and algorithms like the event-driven approach enable the very fast simulation and characterization of mixed-signal systems, reducing drastically the needed design time and thus the time to market gap. These methods are linked via well-defined interfaces with established software, such as Cadence/Spectre, SPICE or Matlab/Simulink, to enable efficient and robust top-down designs and bottom-up verifications.

### Design of Electrical and Multi-Physical Systems

The spectrum of tasks during the development of complex micro and nanoelectronic systems encompasses all relevant areas of system design, starting from the chip, through packages and modules right up to the PCB. A major focus of this work lies on the characterization of complex electronic systems by modeling, simulation and measurement of parasitic electromagnetic effects. For this purpose the department ASE employs several commercial simulation tools, such as CST Studio Suite and Agilent ADS, as well as highly sophisticated measurement instruments that allow for the analysis of a large diversity of parasitic effects. The combination of these disciplines allows to characterize and analyze new technologies like e.g. wireless power and data transfer, 3D molded interconnect devices (3D-MID) and sensor systems even before manufacturing prototypes.

Since with increasing levels of complexity of systems to be simulated the time costs and therefore the overall costs increase, an efficient and precise modeling that enables significant reductions in calculation time is needed. Thus, techniques are analyzed in order to find the transmission behavior of very diverse structures that best approximate the time and frequency domain behavior. For nonlinear systems this is achieved by using neuronal networks. By employing specific methods to identify parameters and systems, the input and output behavior of complex systems can thereby be approximately described. For the class of nonlinear systems new concepts, methods and algorithms are being researched and developed

as well as automated design concepts (i.e. hardware/software co-design) that are linked with commercial software products are being created.

A further key research area, the department ASE is focused on, is the analysis and advancement of accurate and very time and computer resource efficient event-driven simulation models for mixed-signal systems. An example for such a system is the phase-locked loop (PLL). It is required in applications ranging from modulation and demodulation, clock and data recovery up to the synchronization and frequency synthesis. For an optimal and robust design of PLLs an efficient model for the highly nonlinear behavior of such circuits is essential. Hence, non-ideal effects like e.g. dead zone, voltage controlled oscillator characteristic and noise are being incorporated into an event-driven model to optimize the design for a large range of different boundary conditions as well as to increase overall quality of the application.

Fig. 1: Wireless supply of consumer electronic.  
 Fig. 2: Near-field electromagnetic mapping on chip level.  
 Fig. 3: Efficient modeling for fast simulations and design of mixed-signal systems.  
 Fig. 4: Signal integrity simulation of a 3D system for automotive application.

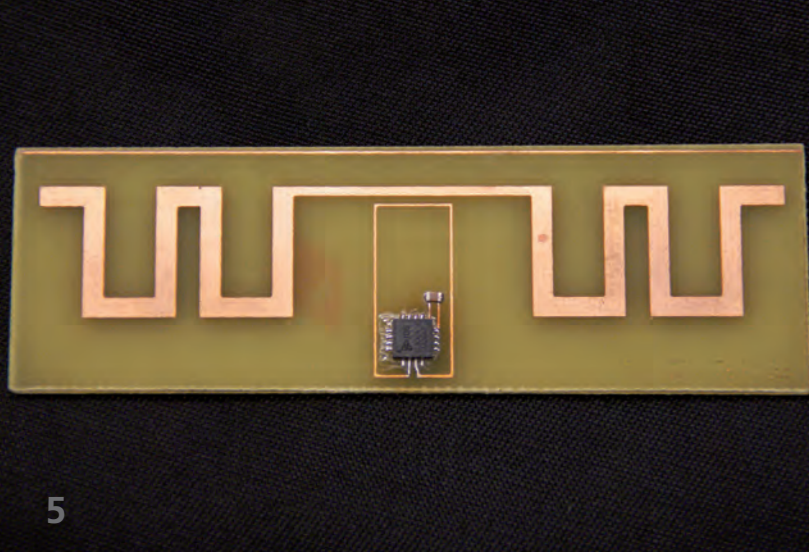

5

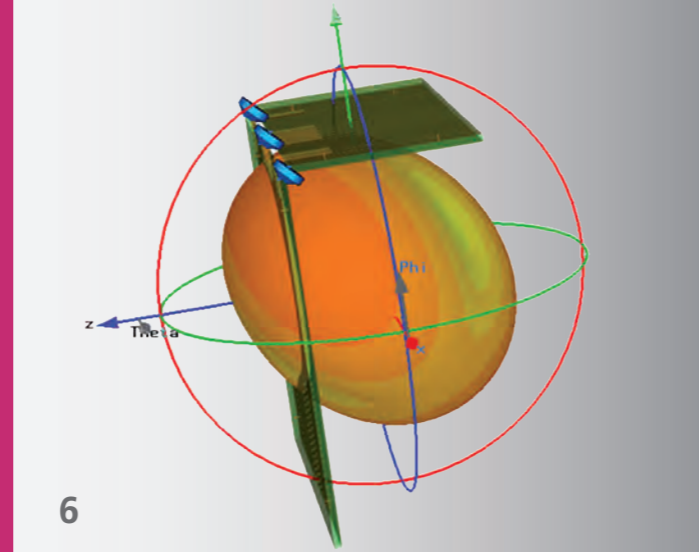

6

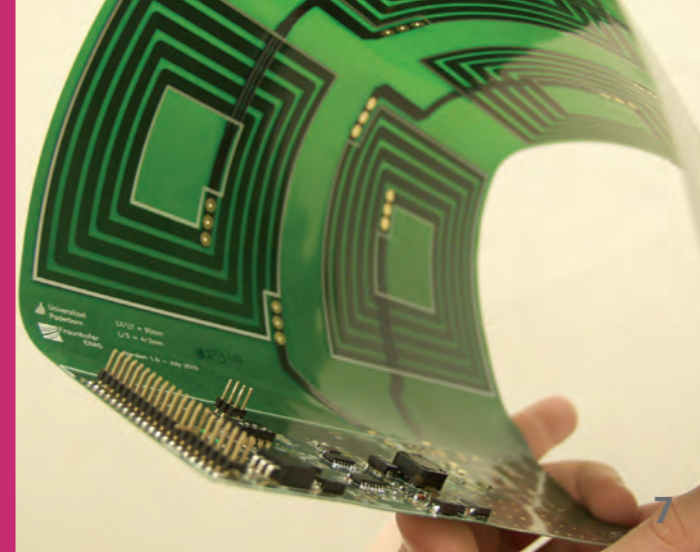

7

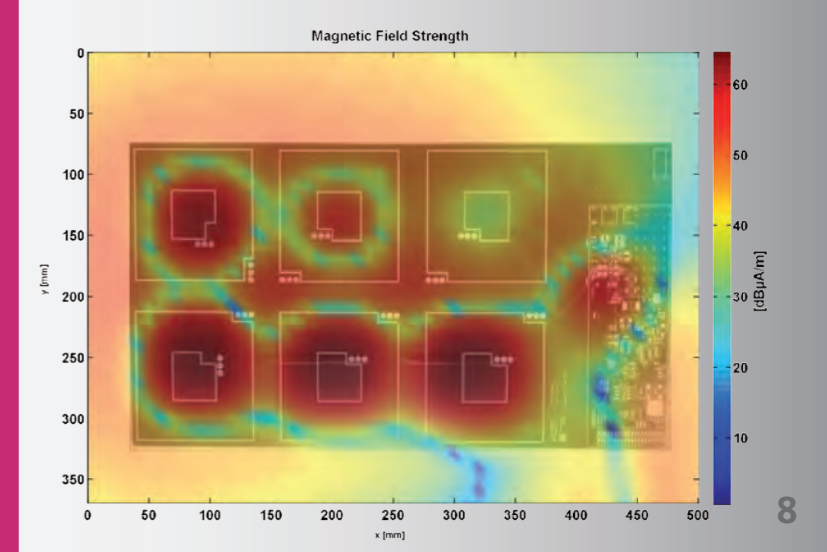

8

### Wireless Sensor Systems

Modern industrial systems such as conveyor and production systems, wind turbines or aircrafts, are exposed to high loads and an associated wearout. To avoid failures due to unforeseen defects, a continuous sensory monitoring of such components is crucial. In this context, the engaged sensor systems must generate a digital and failure-free output signal that automatically adapts to the input variables of event space and allows an independent signal optimization by the fusion of different input signals (e.g. temperature, power, speed, acceleration, etc.). The parallel detection of several system parameters and the combination of various sensor signals allow the detection and compensation of defective sensors or faulty information in situ. At the same time, the sensor data should be measured directly on the manufactured work piece or critical moving parts (drives, blades of wind turbines). This limits the use of classically wired sensor systems largely. To overcome the limitations, small sensors that permanently monitor their surroundings and transmit observed data wirelessly form the core of such systems. These sensors usually require a processor, some memory and a wireless sending and receiving unit for the assessment and the transmission.

In order to allow a sensor to run autarkic it needs an integrated energy supply. Most easily a battery can be applied. However, for employing sensors without a time limitation and without the need of maintenance, an energy-harvesting concept that uses external energy from sources as sunlight, warmth, vibrations, movement or even a wireless energy supply has to be imple-

mented. Especially in the field of energy supply of such systems the ASE has many years of experience in the development and deployment of intelligent RFID systems and the inductive energy transfer under harsh industrial conditions collected in a large number of funded and industrial projects. This knowledge base on highly efficient modeling and analysis methods for the characterization of high frequency electromagnetic systems, takes hard EMC conditions among others into account. Our department is researching the realization and integration of complete sensor systems that incorporate existing methodologies and technologies from the fields of sensor technology, wireless data and energy transmission, as well as energy harvesting. The highest demands are made regarding complete systems in respect to energy efficiency, flexibility and overall size. They are also required to be multifunctional and cost-effective. In order to be able to efficiently dimension, optimize and read a new sensor, it is necessary to adapt or re-design the assessing electronics, the energy supply and the transmission of data for every individual application situation. Therefore it is the goal of the research and development conducted by the department ASE to provide innovative, customer-orientated solutions for the optimization of existing methods and techniques.

Fig. 5: RFID design for specific harsh environment applications.

Fig. 6: Far field of smart sensor module.

Fig. 7: Flexible antenna array for wireless energy transmission.

Fig. 8: Near-field measurement of the magnetic field in an antenna array.

### Wireless Energy Supply

When considering the area of wireless communications, many different interfaces has been established, supporting the global strategy of Internet of Things. Recent issues of electronic devices show a growing need of wireless energy supply for portable devices and intelligent systems with embedded sensors and actuators. The energy supply system of current mobile equipment used in medicines (like implants), industrial production environments or consumer electronics (like smartphones) based on a cabled energy supply or chemical energy storage (like batteries) has to be maintained and regularly replaced or recharged. Thus, the most important advantage of a wireless energy transmission system is related to the spatial positioning freedom it offers, avoiding complicated chunky cabling and galvanic contacts. A further advantage of a contactless energy system is given by the possibility of encapsulating hermetically the systems, isolating them from unwanted external impacts (like dust, humidity, heat, etc.).

In order to supply a device wirelessly with energy, several feasible methods exist and rely on different physical concepts. In the case of a near-field transmission, the inductive and the capacitive couplings are recommended. For higher ranges, the energy transmission can take place using electromagnetic propagating waves. By considering the classical inductive coupling technology, coils and ferromagnetic materials are used in order to guide the magnetic field from the transmitter to the receiver. Such designs operating in low frequencies typically lead to bulky and heavy structures which restrict their integration

within surfaces or limited volumes. A space-saving integration is achieved by using higher frequencies which allow the use of conventional printed circuit boards for the antenna design. At the same time, these higher frequencies offer the possibility of optimized efficiency combined with higher transmitted energy to be transmitted. Typical point-to-point RFID-based energy transmission systems (RFID or other systems) operate with frequencies ranging from 70 kHz up to 30 MHz. With such techniques, the transmittable energy is in the magnitude of 100 mW up to 100 W with an efficiency comparable to the charging and discharging cycle of accumulator systems.

The increase of both efficiency and positioning freedom of wireless energy transmitting systems taking into account the legislative electric smog limits is a top technological issue for the market penetration of wireless transmitting systems. Only an emission-reduced architecture can allow applications in close proximity to human beings or in EMC critical environments. To achieve this, the department ASE has developed an array of juxtaposed and interlaced coils which are controlled separately. By detecting the presence or absence of an authorized receiver, only the transmitting coil in front of a corresponding receiver is activated, increasing the transmission efficiency by minimizing the radiated unwanted fields. Based on this very innovative approach, the department ASE has built up a solid know-how in the area of wireless energy transmission which is offered as technological upgrade service in application domains like medical devices, industrial automatization and consumer electronics.

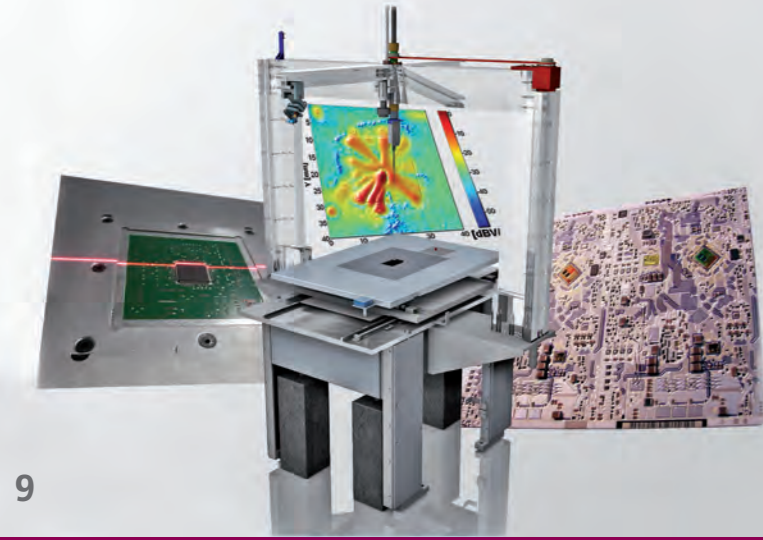

9

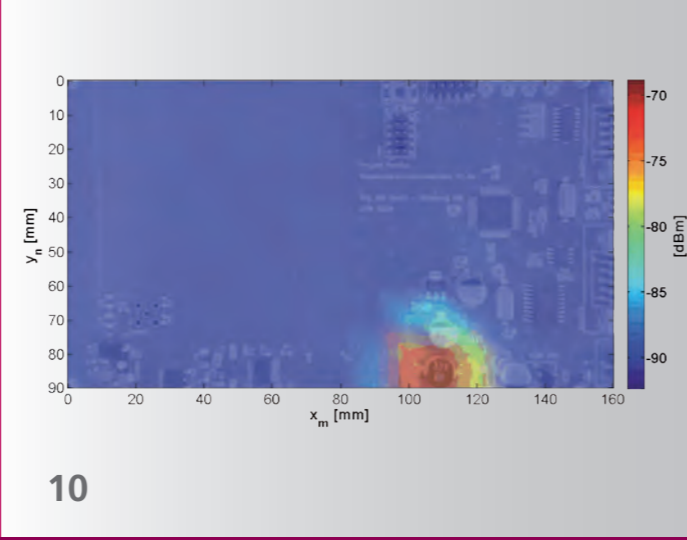

10

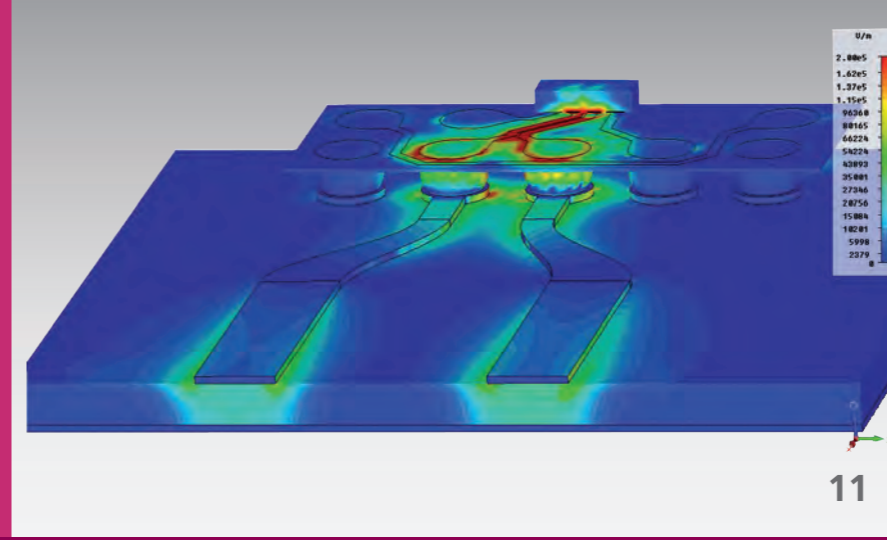

11

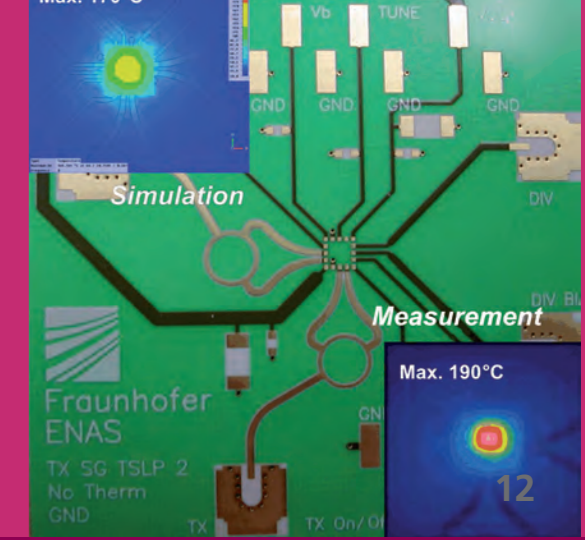

12

### Electromagnetic Near-Field Measurement Techniques

The More-Moore and More-than-Moore assembly trend of smart low-power electronic systems make the components become continuously smaller integrating heterogeneous functionalities with smaller switching times and therefore reduced energy consumption. In parallel, the signal-to-noise ratio decreases, making every new generation of a circuit more sensitive. For the developers of electronic circuits this results in increasing electromagnetic compatibility issues. Not only the electronic device itself needs to be protected but progressively each individual component on the printed circuit board must be considered. These boundary conditions require a focus on the parasitic influences during the system design to guarantee a flawless design. By using appropriate EDA tools and simulators, it is possible to analyze a multitude of such parameters in the design phase. However this does not allow for sufficient security, since the ratio between the biggest dimension (PCB) and the smallest structure (bond wire) can differ by several orders of magnitude and leads to extremely complex 3D models. Indeed, the radiating characteristics are directly determined by the switching behavior of the circuit and its geometric structure. Moreover, the internal signal level and the internal signal form of integrated circuits are not known and therefore assumptions have to be made.

Near-field measurement technique provides a mitigation to this problem. They allow the precise detection of weak electric and magnetic fields within a resolution of a hundredth of a millimeter and can be employed for the characterization and discrimination of potential electromagnetic interference (EMI) sources in active systems. This measurement technology has the ability not

only to locate EMI sources locally but also spectrally. Thanks to this dual property, it is possible to quickly and directly identify and correct conception faults at early design stages. However, near-field measurement systems need to be adjusted to the specific requirements of EMC compliance measurements. For these adjustments, the department research focuses on the influence of the near-field probe on the field to be analyzed itself and has developed methodologies to compensate this influence.

Such compensation is necessary, since a real probe is not only sensitive to the desired field component (i.e. the normal component of the E-field) but also on other field components such as the tangential E- and H-fields. A central research point of the department ASE related to this issue is the continuous improvement of the mechanical and electronic components of the near-field scanning system.

Beside the application field of EMC, the high and wide-band sensitivity of the developed near-field measurement technology allows the electromagnetic analysis of security-relevant systems such as smart cards, which is a new and promising application area of this advanced measurement system. By using near-field measurement methods it is possible to uncover weaknesses in such systems and elaborate countermeasure strategies.

Fig. 9: Advanced near-field measurement system.

Fig. 10: Near-field measurement of an RFID structure with localized EMC-disturbance.

Fig. 11: Electronic simulation of an optimized eWLB package.

Fig. 12: Thermal analysis of a PCB assembly: simulation and measurement.

### Services and Measurement Techniques

The department Advanced System Engineering provides customer-specific developments for industry and research institutes. All presented areas of research are available for services. In the following a short survey of special services and used measurement techniques is listed.

We offer the following services:

- ▶ Research and design of customer-specific electronic modules
- ▶ Model-based development methodologies for heterogeneous systems
- ▶ Development and optimization of RF antenna structures and circuits (RFID, WLAN and others) based on simulation and measurement methods
- ▶ Development of wired and wireless sensor systems
- ▶ EMC and EMR analysis, characterization and modeling of micro and nano electronic circuits and of parasitic electromagnetic effects
- ▶ Signal integrity analyses

Equipment:

- ▶ 3D near-field scanner for DUT sizes up to 50 x 80 x 50 cm; frequency range: DC – 6 GHz; optical contour determination of DUT surface
- ▶ 4-port network analyzer (Agilent N5230A): frequency range: 30 kHz – 20 GHz; application: vectorial characterization of 4-port networks
- ▶ Impedance analyzer (Agilent 4294A): frequency range: 40Hz–110 MHz; application: characterization of lumped complex

components, single port networks in low frequency domain

- ▶ Spectrum analyzer (HP 8563 E): frequency range: 9kHz–26 GHz; application: scalar frequency domain measurements, e.g. analysis of radiated spectrum of DUT
- ▶ Communication Signal Analyzer (Tektronix CSA 803): application: Time Domain Reflectometry characterization of transmission paths (20 GHz bandwidth), localization of impedance mismatches in transmission lines (e.g. cables) with ~5mm resolution, high-speed sampling oscilloscope (up to 50 GHz)
- ▶ FCC TEM Crawford Cell (FCC-TEM-JM1): frequency range: DC – 1200 MHz; application: immission and emission analysis for small objects such as ICs, modules, etc.
- ▶ Waferprober Cascade Summit 9000: application: direct RF-conform probe testing of wafers or micro systems; probes can be placed with micrometer precision
- ▶ 4-channel oscilloscope (LeCroy waveRunner 640zi): band width: 4 GHz, 40 GS/s; application: characterization of high-frequency time domain signals, analysis of single events in long-time intervals by software controlled event triggers, synchronous analysis of analog (4 channel) and digital (18 channel) signals.

Simulation Environment:

- ▶ CST STUDIO SUITE: Complete technology for 3D EM simulation; application: analysis of electromagnetic, electrostatic, magnetostatic and thermal behavior of 3D structures, combination of 3D simulation and circuit simulation results
- ▶ ANSYS Multiphysics application: 3D simulation of electromagnetic, mechanical and thermal effects

Contact details:

Fraunhofer Institute for Electronic Nano Systems ENAS  
Department Advanced System Engineering

Warburger Strasse 100  
33098 Paderborn  
Germany

Head of department Advanced System Engineering:  
Dr. Christian Hedayat

Phone: +49 5251 60-5630  
Fax: +49 5251 60-5621  
E-mail: [christian.hedayat@enas-pb.fraunhofer.de](mailto:christian.hedayat@enas-pb.fraunhofer.de)  
Internet: <http://www.enas.fraunhofer.de/EN>

*Front page:*

*Complex antenna matrix structure and electronics for wireless  
energy transmission.*

*Photo acknowledgement: Fraunhofer ENAS*